

SlabDrain - H200K-13 galvanized steel edge rail channel system

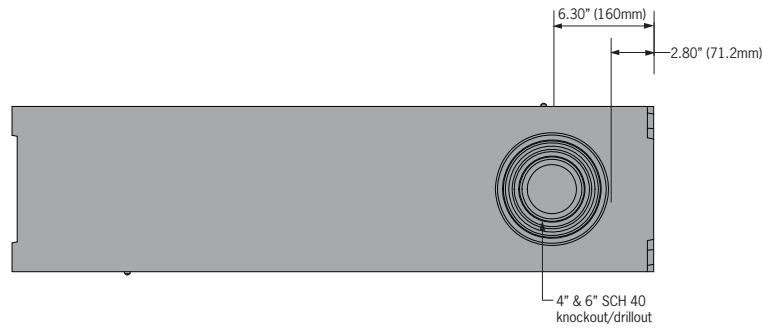

H200K-13

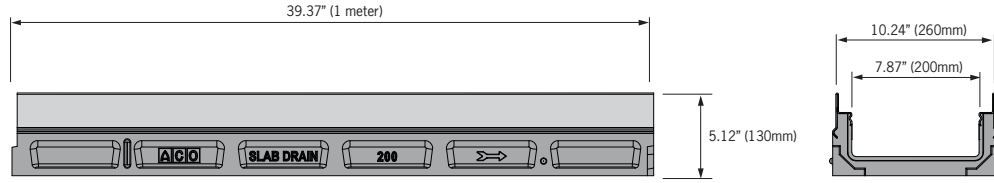

Outlet flow rates

Product	Outlet size (Sch. 40)	Invert Depth	GPM	CFS
H200K-13 channel	4" round	4.00	108	0.24
H200K-13 channel	6" round	4.00	243	0.54

Note: These are the pipe flow rates at the specified outlet, NOT channel flow rates.

ACO Specification Information

ACO DRAIN

SlabDrain - H200K-13 galvanized steel edge rail channel system



Description	Part No.	Invert Depth		Weight lbs.
		inches	mm	
H200K-13 - Polyester polymer concrete H200K-13 Neutral channel - 39.37" (1m)	93454	4.00	100	57.4
H200K-13 closing end cap	93458	4.00	100	1.0

Notes:

1. Add nominal 0.6" (15mm) to invert depth for overall channel depth
2. Preformed Sch. 40 4" & 6" dia. drill-out cast on underside of each channel
3. Use QuickLok/PowerLok grate removal tool to remove grates (Part # 01318)

Specifications

General

The surface drainage system shall be ACO Drain SlabDrain H200K-13 complete with gratings secured with 'QuickLok' as manufactured by ACO Polymer Products, Inc. or equal approved.

Materials

The trench system bodies shall be manufactured from polyester polymer concrete with minimum properties as follows:

Compressive strength: 14,000 psi
 Flexural strength: 4,000 psi
 Water absorption 0.07%
 Frost proof
 Salt proof
 Dilute acid and alkali resistant

The nominal clear opening shall be 7.87" (200mm) with overall width of 10.24" (260mm). Pre-cast units shall be manufactured with neutral invert and have a wall thickness of at least 0.5" (13mm). Each unit will feature a male to female interconnecting end profile. Units shall have horizontal cast in anchoring features on the outside wall to ensure maximum mechanical bond to the surrounding bedding material and pavement surface. The galvanized steel edge rail will be integrally cast in by the manufacturer to ensure maximum homogeneity between polymer concrete body and edge rail. Each edge rail shall be at least 1/8" (3mm) thick.

Grates

Grates should be specified. See separate ACO Spec Info grate sheets for details. After removal of grates and 'QuickLok' bar there shall be uninterrupted access to the trench to aid maintenance.

Installation

The trench drain system shall be installed in accordance with the manufacturer's installation instructions and recommendations.

ACO Polymer Products, Inc.

Northeast Sales Office
 P.O. Box 245
 Chardon, OH 44024
 Tel: (440) 285-7000
 Toll free: (800) 543-4764
 Fax: (440) 285-7005

West Sales Office
 P.O. Box 12067
 Casa Grande, AZ 85130
 Tel: (520) 421-9988
 Toll Free: (888) 490-9552
 Fax: (520) 421-9899

Southeast Sales Office
 4211 Pleasant Road
 Fort Mill, SC 29708
 Toll free: (800) 543-4764
 Fax: (803) 802-1063



Electronic Contact:
 info@ACODrain.us
 www.ACODrain.us



© March 28, 2013 ACO Polymer Products, Inc. This information is believed to be accurate but it is not guaranteed to be so. We cannot assume liability for results that buyer obtains with our product since conditions of use are beyond the control of the company. It is the customer's responsibility to evaluate suitability and safety of product for his own use. ACO Polymer Products Inc. reserves the right to change the product and specifications without notice.